



BIDHAN CHANDRA KRISHI VISWAVIDYALAYA

MOHANPUR, NADIA
WEST BENGAL-741252

From:
Prof. D Saha , PI, FMTTI

9432259894 / 9903471790(M)
email:dsaha62@yahoo.co.in

Ref No :BCKV/FMTTI/2019-20 / 18

Date: 04.03.2020

Tender ID No. 2020_BCKV_277378_1

Notice Inviting E-Tender

Principal Investigator, FMTTI, BCKV, is inviting tenders from competent and *bonafide* vendors/ parties/ distributors/ dealers/agents/ manufacturers having registration of VAT for supply of following items to the BCKV, as per **specifications appended bellow**. Quotation of items must include essential accessories with make also, from branded company, in Indian Rupees only, even if the main equipment is quoted in foreign currency. Without essential accessories tender will be considered as incomplete. Quoted rates of all the items, including imported ones are must be FOR DESTINATION (up to delivery at the laboratory/centre) and satisfactory installation and demonstration. Vendors are requested to include the cost involved in transportation from airport to laboratory, airport tax, custom duty (if applicable), etc in their quotation. However, University will provide valid DSIR and authorization certificate to the clearing agent, if require.

Quotations are invited Bid papers must accompany authorization certificate from original manufacturer, trade license, credentials in the relevant field. Vendor who will sign the bid on behalf of company or firm must produce registered documents in respect of their competency and specificity on demand. The authority **reserves the right to accept or reject any tender without showing reason**. Draft must be in favour of '**Bidhan Chandra Krishi Viswavidyalaya**' payable at Kolkata and payment will be released as per BCKV rules.

Eligibility criteria for participation in tender:

ELIGIBILITY CONDITIONS

Eligibility Conditions for Bidders

1. Minimum Eligibility Conditions: The Bidders should be

1.1 The Bidder should have valid /PAN/TIN/GST registration certificate. A copy of which should be enclosed

N.B.The credentials should be uploaded in the form of completion/payment certificate from the competent authority clearly mentioning name, address, contract no of the office and executed amount against the work

1.2 The intending bidder must have to produce an authorize document with the manufacturers (manufacturers authentication certificate for all items of each group as a manufacturer and must produce a scanned copy of the Authorization must have to be uploaded with the Technical Bid documents. Otherwise the tender will be liable for rejection.

1.3 Pan Card, Professional Tax receipt Challan for the current year, GST registration Certificate to be accompanied with the Technical Bid documents.

1.4 The prospective bidders should own or arrange through lease hold agreement the required plant and machineries, Conclusive proof of ownership/Arrangement must be submitted along with other relevant supporting papers. (Non statutory Documents)

1.5A Prospective bidder shall be allowed to participate in the particular job either in the financial capacity of individual or as a partner of a firm. During Technical Evaluation of bid, financial capability to execute the work may be verified by the tender Accepting authority/Tender Committee.

1.6 Annual turn-over at least Rs.150.00 lac (One Hundred and fifty lac) only per year for last three consecutive years.

1.7 Specifications of the Items as per following :

Manufacturer should have Green Guard certification along with products certifications like; AIOTA, INDIAN DESIGN MARK, BIFMA level 2 conforms to ANSI/BIFMA e3-2014e Furniture Sustainability Standard issued by BIFMA. Other certificates ISO 9001:2015, ISO 14001:2015, ISO 50001:2011, OHSAS 18001:2007 is mandatory. Manufacturer should have Green Guard Certification for few of its products. All the ISO certificates should be obtained from NABCB (central Govt) accredited organization otherwise certificates will not be accepted. Sample and factory visit is mandatory to inspect as per the requisite.

Earnest Money :

Draft from any nationalized Bank of worth Rs. 65000.00 (sixty five thousand) only must be in favour of 'Bidhan Chandra Krishi Viswavidyalaya'

Refund/Settlement Process:

i. After opening of the bids and technical evaluation of the same by the tender inviting authority through electronic processing in the e-Procurement portal of the State Government, the tender inviting authority will declare the status of the bids as successful or unsuccessful which will be made available.

ii. Once the financial bid evaluation is electronically processed in the e-procurement portal, EMD of the technically qualified bidders other than that of the L1 and L2 bidders will be refunded, through an automated process, to the respective bidders. However, the L2 bidder should not be rejected till the LOI process is successful.

iii. If the L1 bidder accepts the LOI and the same is processed electronically in the e-Procurement portal, EMD of the L2 bidder will be refunded.

iv. The BCKV authority reserves the right to cancel the e-N.I.T. due to unavoidable circumstances and no claim in this respect will be entertained.

v. During scrutiny if it comes to the notice of the tender inviting authority that the credential or any other papers of any bidder is incorrect/Manufactured/fabricated that the tenderer will not be allowed to participate in the tender and that application will be outrightly rejected without any prejudice with forfeiture of earnest money forthwith.

vi. Before issuance of the work order, the tender inviting authority may verify the credential & other documents of the lowest tenderer is either manufacturing or false in that case, work order will not be issued in favour of the tenderer under any circumstances.

Bid Validity:-

The bid will be valid for 60 days from the date of opening of the financial bid.



EXTENSION OF TIME:-



Time shall be considered as the essence of the contract. If, however, failure of the contractor to complete the work as per the stipulated dates referred to above arise from delays on the part of Government in supplying the materials or equipment, it has undertaken to supply under the contract, force measure an appropriate extension of time will be given by the BCKV authority.



Items with specification(s) for which e-tender is invited:



Sl. No	Item	Specification	Fig														
1	Mild Steel Laboratory Cot 10(ten)units	Dimension: 3 feet x 7 feet supported on angle framed structure, finished in attractive colour bunk bed heavily duty + mattress . Deuce Bunk Bed R.lvh.Blue The bunk bed should be of length 215.7 x 84.3 x 165 (cm) .with mattress dimensions of 206.4 x 97.2 (cm).	 <p>DEUCE BUNK BED</p> <table border="1"> <thead> <tr> <th>Dimensions (in cm)</th> <th>Length</th> <th>Width</th> <th>Height</th> </tr> </thead> <tbody> <tr> <td></td> <td>215.7</td> <td>84.3</td> <td>165</td> </tr> </tbody> </table> <table border="1"> <thead> <tr> <th>Mattress Dimensions (in mm)</th> <th>Length</th> <th>Width</th> </tr> </thead> <tbody> <tr> <td></td> <td>206.4</td> <td>97.2</td> </tr> </tbody> </table>	Dimensions (in cm)	Length	Width	Height		215.7	84.3	165	Mattress Dimensions (in mm)	Length	Width		206.4	97.2
Dimensions (in cm)	Length	Width	Height														
	215.7	84.3	165														
Mattress Dimensions (in mm)	Length	Width															
	206.4	97.2															



<p>2</p>	<p>Laboratory Storage Locker Unit 4 Door with lock, with 1 Main Unit and 4 Add On Unit. PLU 4 Door 4(four) units</p>	<p>Unit 4 Door with lock, with 1 Main Unit and 4 Add On Unit. PLU 4 Door Overall size of 4 - Door PLU + Lkr (Base) shall be 380mm(W)x450mm(D)x1830mm(H). DMX Drg.- PL 13-A4-33797,R1 - 4 Sheets(Cam Lock) DMX Drg.- PL-13-A4-36467,R1-4 Sheets(Hasp.) Stackability shall have add - on units that can be stacked width wise to form bank of lockers having common side panel. Locking shall have 10 Lever cam lock with lock lever plus option of hasp arrangement . Material shall be CRCA 0.6 mm thickness . Construction shall be Rigid Knockdown construction , shelf shall be uniformly distributed load capacity per each shelf level is 35 Kg maximum . Finish shall be epoxy polyester powder coated to the thickness of 50 microns . Handle/Label holder shall be Aesthetically appealing Snap fit ABS plastic handle . Ventilation shall be attractive punched pattern for ventilation .</p>	
<p>3</p>	<p>Laboratory Chair with Row Table Enlighten (120+80) seater for smart Class Room Class Room sketch is attached herewith</p>	<p>A)Legs: - Legs are made of MS ERW tube section (157138) of size 75x25x2 mm thick oval tube with 5 mm thk HR brackets as per IS:2062 and 2mm thk CRCA brackets as per IS-513 welded on to the tubes. Assembly is powder coated with epoxy polyester. - Leg height varies from 705 to 1005 in pitch of 50 as per layout. - Sturdy anchoring by anchor bolts on to base of 8mm thk plate for proper resting of Leg**. - Shoe made of ultramid -Nylon are provided at the bottom for covering the base plate. B)Side clads: - Two side clads made of e18 mm thk plate with 0.8mm thk pvc lipping and on the outside covered with welded metal structure made of 2 mm thk CRCA as per IS-513 powder coated with Epoxy polyester . C)Worktop: - Worktop are made of 25 mm thick Pre-Laminated Board of EI-P2 Grade and approved shade conforming to IS:12823:1990. All the edge of work surface are provided with machine pressed 2mm thick pvc edge band glued with hot melt glue. D)Seat: - Seat has self closing mechanism which will operate by means of dead weight . Seat understructure is made from combination of welded fabricated structure of 5mm Thk HR as per IS:2062 and 8mm thk ply as per IS:303 with moulded PU foam of density 55 kg/cu.mtr.</p>	

		<p>on top which in turn is covered with stitched upholstery made of leatherite as per INT/DSN/MSS/UPH1038 or foam back fabric as per TNT/DSN/MSS/UPH/013.</p> <p>Seat assembly is covered on bottom side by means of seat cover made of pp.</p> <p>E)Seat Back:</p> <ul style="list-style-type: none"> - Seat back is made from combination of 8mm thk ply as per 15:303 with moulded foam on top which in turn is covered with stitched upholstery made leatherite as per INT/DSN/MSS/UPH/038 or foam back fabric as per INT/DSN/MSS/UPHJ013. <p>F) Seat Support Frame :</p> <ul style="list-style-type: none"> -Seat support frame is made from combination of MS ERW tube section (IS 7138) of size 80x40x2.5 mm thick rectangular tube and MS ERW tube section(IS 7138), of size 48x19.1x2 mm thick oval tube welded together . Assembly os powder coated with Epoxy polyester. CAP made of ultramidare provided from front to cover the oval tubes. <p>G)Modesty:</p> <ul style="list-style-type: none"> - Modesty is made of 25mm thick pre-laminated twin board of E1-P2 Grade and approved shade conforming to IS:12823:1990. All the edge of modesty are provided with machine pressed 2 mm Thick pvc edge band glue with hot melt glue. 	
<p>4</p>	<p>Dining Chair Unwind 30(thirty) units</p>	<p>The seat and back are made uo injection moulded high impact 50mpound polypropylene polymer compound with indoor 50mpo UV Resistance. The Powder coated (DFT50+ microns) weled tubular frame is made from 2.22 + 0.03 cm x 0.16+/- 0.0128cm and 3.5+/- 0.03 cmx1.5+/-0.03 cm x 0.16 +/- 0.0128 cm M.S.E.R.W tubThe Shoes are made of high impact 50mpound polypropylene polymer 50mpound with indoor grad UV Resistance and pressed fitted with tubularfram. SIZE : (W)52.5cm*(D)55.8cm*(H)84.5cm*(seat H) 45.0 cm</p> <p>Seat Size 52.5cm(W) x 53.2 cm(D)</p> <p>Back Size 51.6 cm(W) x 40.5 cm (H) .</p>	
<p>5</p>	<p>Dining Table-six seater 5(five) units</p>	<p>Length : 150cm Width : 90cm Height :75.7cm</p> <p>TABLE METERIALS & SIZE :TOP: 19mm MDF board with okumevener,Color : Brown Black,LEGS: 720 x 103 x 20 solid wood , Color : Brown Black.</p>	

<p>6</p>	<p>First Impression 3 Arch 2(Two) units</p>	<p>Top shall be of Rubberwood with clean Matt PU finish 18 mm thick , inside radius - 700 mm , outside radius - 1350 mm and depth - 650 mm . Cork shall be 18 mm thick of rubber . Glass shall be Frosted 10 mm thick diamond cut finishing on edges , inside radius shall be - 1202.5 mm , outside radius - 1402.5 mm and depth - 200 mm . The Modesty Panel shall be MS Perforated sheet below worksurface : 0.8 mm (thick) x 665 mm (height) x 1345 mm (flat length) . Above Worksurface : 0.8 mm (thick) x 260 mm (height) x 1345 mm (flat length) . The legs shall be of MS tube 1.6 mm thick diameter 50.8 mm and height 604 mm . .</p>	
<p>7</p>	<p>Nova Pedestal for Reception Table (646H x 390W x 440D) 2(Two) units</p>	<p>Overall Dimensions of Free Standing Ped With Castors For Finesse Table shall be 390mm(W)x440mm(D)x646mm(H). The construction & Material used shall be welded assembled , 0.8 mm thick CRCA for body shell , drawer front & tray , front side stiffener , rear side stiffener and 1.2 mm thick CRCA Top stiffener & Bottom stiffener . The drawer fronts shall be metal front straight edge . Locking shall be 10 lever cam lock & Central RH locking with actuator & lock channel mechanism for box-box-file Pedestal . The top panel shall be metal straight edge top . Castor should be swiveling non - lockable castors mounted below the body shell for free standing full height mobile pedestal and M8 Leveling stud for free standing pedestal . The anti-tipping mechanism shall have fifth roller arrangement mounted below file drawer to avoid toppling of unit when file drawer is pulled out . Partition in drawer shall be 1 no. Partition in box drawers with lock mounted . Plastic pencil tray shall be optional accessory . Finish shall be epoxy polyester powder coated to the thickness of 50 microns . Application shall be suitable for pushing below work surface which has got a clear height of 725 mm from below . For drawer pulling side wise tapered recess provided in shell behind drawer fronts .</p>	
<p>8</p>	<p>Reception Chair 2(Two) units</p>	<p>SEAT ASSEMBLY: The seat should be made up of 1.4 ± 0.1 cm thick liot - prejsedOyvira(Sel, moulded polyurethane foam and upholstered with fabric. MORE INTERIO DESIGN SEAT SIZE: 50.0cm (W)x 49.0cm(D). - - 2. BACK ASSEMBLY: The two part assembly upholstered with Mesh fabric should be made up of back outer injection moulded in glass filled Polyamide and back inner injection moulded in glass filled Polypropylene. The back consist of adjustable Lumbar support</p>	

		<p>made of injection moulded Polyoxymethylene (POM) which should be upholstered with foam and fabric having an adjustment of 5.5 ± 0.5 cm. BACK SIZE: 48.0 cm(W) x 54.5 cm(H). 3. POLYURETHANE FOAM: The polyurethane foam for seat should be of density = 55 ± 3 kg/m³. 4. FOUR-WAY ADJUSTABLE ARMRESTS: It should be made of glass filled Polyamide arm structure with PU armtop and height adjustment of 9.0 ± 0.5cm. The armtop has swivel, side-to-side and to-and-fro movements. 5. MECHANISM: The mechanism should be designed with the following features: • 360° revolving type. • Auto-balance synchro - tilt • 4 position (including upright lock) giving option of variable tilt angle to the chair. 6. SEAT DEPTH ADJUSTMENT: Seat depth adjustment should be integrated in the seat through a sliding mechanism. Seat depth adjustment range should be of 4.5 ± 0.5 cm. 7. PNEUMATIC HEIGHT ADJUSTMENT: The CLASS-4 pneumatic height adjustment has stroke of 9.5 ± 0.5cm. 8. PEDESTAL ASSEMBLY: The pedestal should be injection moulded in glass filled Polyamide and fitted with 5 nos. twin wheel castors. The pedestal should be 67.0 ± 0.5 cm P.C.D. 10. TWIN WHEEL CASTORS: The twin wheel castors are injection moulded in Polyamide having 6.0 ± 0.1cm wheel Diameter. .</p>	
<p>9</p>	<p>Storage Cabinet(Drawer type) 2(Two)Units</p>	<p>SERIES TOOL STORAGE CABINET . CODE: F DF 1090 52 04 .Dimensions (in mm): 717 L X 600 D X 1000 H . Number of Drawers: 6 . Each drawer Load Capacity: 70 KG . Height of Each Drawer: 150 mm . Overall Cabinet load capacity: 800 kg . COLOUR: BLUE RAL - 5012 .</p>	
<p>10</p>	<p>Tool Cabinet(Door Type) 2(Two)units</p>	<p>SERIES PERFORM CABINET . Dimensions (in mm): 1023 L X 555 D X 2000 H . Number of Shelves: 4 . Each Shelf Load Capacity: 100 KG . Overall Cabinet load capacity: 800 kg . COLOUR: BLUE RAL - 5012 .</p>	

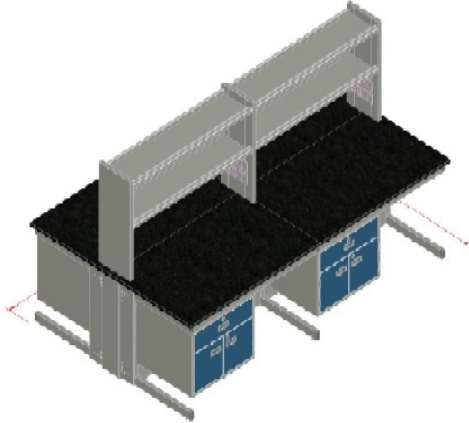
<p>11</p>	<p>Sofa – Three seater 1(One) unit</p>	<p>SERIES PERFORM CABINET . Dimensions (in mm): 1023 L X 555 D X 2000 H . Number of Shelves: 4 . Each Shelf Load Capacity: 100 KG . Overall Cabinet load capacity: 800 kg . COLOUR: BLUE RAL - 5012</p>	
<p>12</p>	<p>Sofa Single Seater 2(Two) units</p>	<p>Overall Size : Width : 111cm Depth : 93.5cm Height : 89cm Seating Height : 47.5cm. stitching: thread- polyester. pitch- 5 stitch per inch(pitch of thread i.e. stitch per inch). leather/pvc/fabric: (pu/pvc/cotton/ polyester/ composite)- fabric : d3/d5/d6 leather look fabric 100%polyester. thickness (mm) :0.9mm. weight (gsm) : 250g/m2. tensile strength {wrap/weft} (kg/cm) :nil. bursting strength (kg/cm2) :nil. colour fastness to rubbing {dry /wet} (scale 1-5) :grade4. frame material (tropical wood / pine wood/ rubber wood): solid plywood frame. moisture content (10 – 12 %) :less than12%. thickness of plywood used(mm) :9mm/12mm/18mm/30mm. standard of plywood used: {required standard : is 303 commercial plywood}. seat foam: (density, type)- thickness (mm) :100mm. density (kg/m3):30. type of foam (virgin/composite/moulded/ slabstock) :seat foam:5cm pure foam 3030(30density)+5cm rebond foam. covering :decron sheet spec.150g 70g. back foam: (density, type)- solid decron 7d/64mm. belt/ webbing material:nylon webbing- width of belt (mm) :back:45mm/seat:50mm..</p>	
<p>13</p>	<p>Lab Stool- Revolving type 40(Forty)Units</p>	<p>seat assembly: li should be circular type 0 30.0±0.5cm and made up of 0.1±0.012cm thkcr steel. it should be welded to the understructure and black powder coated (dft 40-60 microns)understructure assembly: the understructure should be made of ms tube 0 2.2±0.03cm x 0.16±0.0128cm thkmsrw tube. it should be welded to the ms fabricated circular seat assembly and black powder coated (dft 40-60 microns). the understructure should be provided with black pp injection moulded ferrules.</p>	

<p>14</p>	<p>Lab Table with Granite)Top 5(Five) Units</p>	<p>Providing & fixing L 2400 x D 600 mm clear granite counter, including 18mm thick poshied granite front facia, cutting and creating hole in slab and stone with counter alternative storage below and above granite top made with CRCA steel with epoxy power coated finish with 50 microns +/- 10) .</p>	
<p>15</p>	<p>3 Seater Chair on Beam 3(Three) units</p>	<p>The seat and back are made up with injection moule high impact strength polymar compound with indoor grade UV resistance. Seat size 52.5 cm x 53.2 cm. Back size 51.6 cm x 40.5 cm. Poder coated welded tublar frame fitted on obe Beam supported by two pedestal.</p>	

Date & Time Schedule

Tender Publishing Date:	05.03.2020
Document download/Start date:	05.03.2020
Bid submission Start date:	05.03.2020
Bid submission closing date	23.03.2020
Bid opening date	25.03.2020
Bid Opening Office of BCKV, Mohonpur Nadia	

PI, FMTTI , BCKV, Mohonpur



Basic Details			
Organisation Chain	BIDHAN CHANDRA KRISHI VISWAVIDYALAYA		
Tender Reference Number	BCKV/FMTTI/2019-20 / 18		
Tender ID	2020_BCKV_277378_1		
Tender Type	Open Tender	Form of contract	Item Rate
Tender Category	Goods	No. of Covers	2
General Technical Evaluation Allowed	No	ItemWise Technical Evaluation Allowed	Yes
Payment Mode	Offline	Is Multi Currency Allowed For BOQ	No
Is Multi Currency Allowed For Fee	No	Allow Two Stage Bidding	No

Payment Instruments			Cover Details, No. Of Covers - 2			
Offline	S.No	Instrument Type	Cover No	Cover	Document Type	Description
	1	DD - Demand Draft	1	Fee/PreQual/Technical	.pdf	nit
			2	Finance	.xls	boq

Other Important Documents				
S.No	Category	Sub Category	Sub Category Description	Format/File
1	CERTIFICATES	CERTIFICATES	VAT/SALES TAX REGISTRATION CERTIFICATE ALONG WITH ACKNOWLEDGEMENT , PAN, LATEST IT ACKNOWLEDGEMENT, PTAX, LABOUR LICENCE	
2	CERTIFICATES	GST Registration Certificate	GST Registration Certificate	
3	CERTIFICATES	The Micro, Small and Medium Enterprises Certificate	The Micro, Small and Medium Enterprises Certificate	
4	CERTIFICATES	P/ L and Balance Sheet 2016-2017	P/ L and Balance Sheet 2016-2017	
5	CERTIFICATES	Permanent Account Number	Permanent Account Number	
6	COMPANY DETAILS	COMPANY DETAILS 1	PARTNERSHIP DEED, CO-OPERATIVE SOCIETY BYLAW, MOA, TRADE LICENCE, COMPANY REGISTRATION CERTIFICATE	
7	CREDENTIAL	CREDENTIAL 1	CREDENTIAL 1	
8	CREDENTIAL	CREDENTIAL 2	COMPLETION CERTIFICATES	
9	DECLARATION	DECLARATION FILE 1	DECLARATION FILE 1	
10	FINANCIAL INFO	SERVICE TAX	SERVICE TAX	
11	FINANCIAL INFO	P/L AND BALANCE SHEET 2016-2017	P/L AND BALANCE SHEET 2016-2017	
12	FINANCIAL INFO	P/L AND BALANCE SHEET 2017-18	P/L AND BALANCE SHEET 2017-18	
13	FINANCIAL INFO	P/L AND BALANCE SHEET 2018-19	P/L AND BALANCE SHEET 2018-19	

Tender Fee Details, [Total Fee in ₹ * - 0.00]				EMD Fee Details			
Tender Fee in ₹	0.00			EMD Amount in ₹	65,000	EMD through BG/ST or EMD Exemption Allowed	Yes
Fee Payable To	Nil	Fee Payable At	Nil	EMD Fee Type	fixed	EMD Percentage	NA
Tender Fee Exemption Allowed	No			EMD Payable To	Bidhan Chandra Krishi Viswavidyalaya	EMD Payable At	KALYANI

Work /Item(s)					
Title	BCKV/FMTTI/2019-20 / 18				
Work Description	Supplying, fitting and fixing laboratory furnishing at FMTTI, BCKV, Mohanpur, Nadia				
Pre Qualification Details	Please refer Tender documents.				
Independent External Monitor/Remarks	NA				
Show Tender Value in Public Domain	Yes				
Tender Value in ₹	0.00	Product Category	Equipments	Sub category	Laboratory Furnishing Items
Contract Type	Tender	Bid Validity(Days)	180	Period Of Work(Days)	60
Location	BCKV, MOHANPUR, NADIA	Pincode	741252	Pre Bid Meeting Place	NA
Pre Bid Meeting Address	NA	Pre Bid Meeting Date	NA	Bid Opening Place	BCKV MAIN CAMPUS
Should Allow NDA Tender	No	Allow Preferential Bidder	No		

Critical Dates			
Publish Date	05-Mar-2020 04:30 PM	Bid Opening Date	25-Mar-2020 02:00 PM
Document Download / Sale Start Date	05-Mar-2020 05:00 PM	Document Download / Sale End Date	23-Mar-2020 02:00 PM
Clarification Start Date	NA	Clarification End Date	NA
Bid Submission Start Date	05-Mar-2020 05:00 PM	Bid Submission End Date	23-Mar-2020 02:00 PM

Tender Documents				
NIT Document	S.No	Document Name	Description	Document Size (in KB)
	1	Tendernotice_1.pdf	nit	525.88
Work Item Documents	S.No	Document Type	Document Name	Description
	1	BOQ	BOQ_511852.xls	boq

Bid Openers List			
S.No	Bid Opener Login Id	Bid Opener Name	Certificate Name
1.	mrinal@gmail.com	MRINAL KARMAKAR	MRINAL KARMAKAR
2.	sroy612@gmail.com	SUMANA ROY	SUMANA ROY

Tender Inviting Authority	
Name	Prof. D Saha
Address	Principal Investigator, FMTTI, BCKV, Mohanpur, Nadia

Tender Creator Details	
Created By	SUMANA ROY
Designation	DEPUTY DIRECTOR OF RESEARCH
Created Date	05-Mar-2020 03:32 PM